

TELEPHONE SETS FOR INDOOR LOCATIONS — 300 SERIES

IDENTIFICATION AND ASSEMBLY OF PARTS

1.00 GENERAL

1.01 The telephone sets in this section are anti-sidetone sets consisting of a handset and a telephone set mounting which, in addition to a dial or apparatus blank, houses a ringer, capacitors, induction coil, and, in certain cases, an electron tube or an amplifier.

1.02 The housing material in these sets may be either metal or plastic.

1.03 Table A lists components for 300-type sets.

1.04 Table B provides information on general use of sets for indoor use in the 300 series.

2.00 IDENTIFICATION

2.01 Table C lists telephone sets available for common battery manual, dial, or local battery service.

2.02 The 302-type telephone set shown in Figs. 1, 2, and 3 is used on common battery non-polarized ringing lines in manual or dial areas.



Fig. 2 — 302G Telephone Set — Exterior

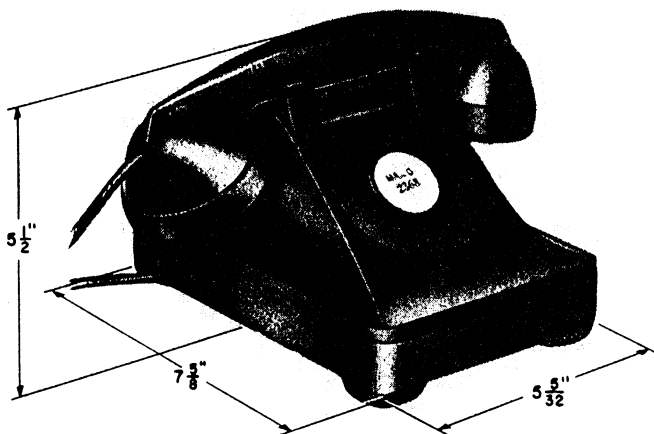

Fig. 1 — 302A or 302E Telephone Set — Exterior

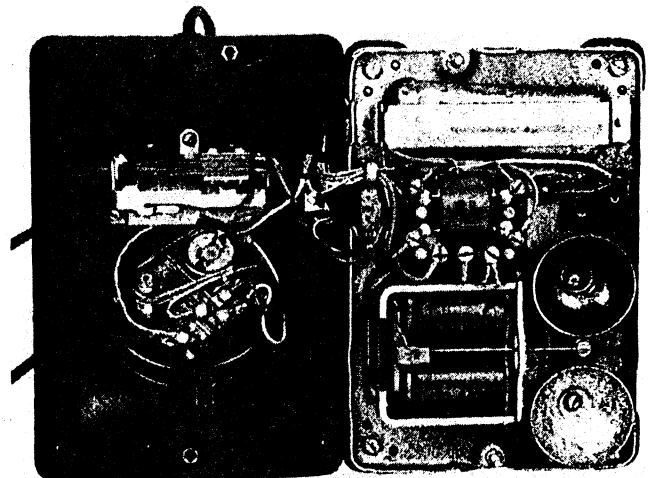

Fig. 3 — 302G Telephone Set — Interior

TABLE A
LIST OF COMPONENTS

Telephone Set	Handset	Dial	Apparatus Blank	Induction Coil	Ringer	Capacitor	Filter	Mounting Cord	Electron Tube	Key	Retardation Coil	Ampl
302E*	FIG	6A or 5HA	82A, 94A	101A	B1AL	195A	61P	D3BF or D3BK				
302F*		6A or 5HB										
302G*		6A or 5HE										
302H*												
302AA*		6A or 5HB	82A, 94A	101A	B1AL		61P†					
302AC*		6A or 5HA	82A, 94A	101B	B2AL	195A	61P	D3BF or D3BK				
304A*	FIG	6A or 5HA	82A, 94A	101A	B1AL	195A	61P	D3BF or D3BK		560A		
304B*		6A or 5HB										
304C*		6A or 5HE										
304D*												
305E*		6A or 5HA	82A, 94A	101A	B3A	195C						
305F*	FIG	6A or 5HB	82A, 94A	101A	B3A	195C	61P	D3BF or D3BK	372A or 426A		266A	
305G*		6A or 5HE										
305H*												
306A*												
306B*	FIG	6A or 5HA	82A, 94A	104A	B1AL	387A	61P	D5AA				
306C*		6A or 5HB										
306D*		6A or 5HE										
306G*		6A or 5HB										
307A†		6A or 5HA	82A, 94A	104A	B1AL							
307B†	FIG	6A	82A, 94A	104A	B1AL	387A	61P	D5AA			266A	
307C†												
307E*		6A or 5HA										
307F*		6A or 5HB										
307G*		6A or 5HB	82A, 94A	104A	B3A	195A	61P					
309A†	FIG	6A or 5HB	82A, 94A	101A	B1AL	195A and 129F	61N	D5AA	426A or 405A		266A	111B
309C†												
332A*		6A or 5HB										
332C*		6A or 5HB										
334C*		6A or 5HB	94A	101B	B2AL	195A	61E or 61G					
354A†	FIG	6A or 5HB	94A	101A	B3A	195C	61E or 61G		426A		266A	
354C†												
356A†		6A or 5HB										
356C†												
357A†		6A or 5HB	94A	104A	B1AL	387A						
357C†												

* Mfr. Disc.
† Standard.
‡ 302A and AC telephone sets must be equipped with a 61-type filter. Filters on other sets are optional.

TABLE B
300 SERIES TELEPHONE SETS — PRINCIPAL USES

Type Set	Use
302	For general use — manual and dial areas.
302AA, 302AC	Multiparty rural lines — lift plunger to talk.
304	For general use — tip party identification.
305	Ringer cutoff feature.
306	Tube sets for polarized ringing.
307	Local battery set for nonpolarized ringing.
309	Local battery-tube set for polarized ringing.
332, 334	For customers requiring receiver amplifications.
354	Wall set for general use.
356	Wall set with tube for polarized ringing.
357	Wall set for local battery service.

TABLE C
CODES OF 300-TYPE TELEPHONE SETS

Type Service		Type Set										
		302	304	305	306	307	309	332	334	354	356	357
Manual	A		•		•	•	•	•		•	•	•
	AA	•										
	E	•		•		•						
Dial	AC	•										
	B		•		•	•						
	C		•		•	•	•	•	•	•	•	•
	D		•		•							
	F	•		•		•						
	G	•		•	•	•						
	H	•		•								



Fig. 4 — 302AC or 306G Telephone Set — Exterior

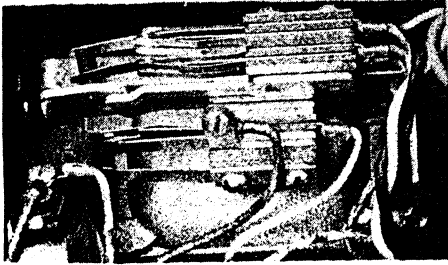

Fig. 5 — 302AA, 302AC, or 306G Plunger Spring Assembly

2.03 The 302AC telephone set shown in Figs. 4 and 5 is designed with a *lift plunger to dial or talk* feature for use on multiparty rural lines. This minimizes interference with dialing and ringing and prevents transmission loss caused by the removal of a station handset while a conversation is in progress. This is done with an additional set of contacts that close when the right-hand switch-hook plunger is lifted. Lifting plunger completes transmitter and dialing circuit of the set. The words *lift plunger to dial or talk* are stamped on the housing between the two plungers.

2.04 The 304-type telephone set has the same external appearance as the 302-type telephone set shown in Figs. 1 and 2. It is used in dial common battery central office areas for tip party identification. The 304A telephone set is for use in manual areas which are to be converted to dial service requiring tip party identification.

2.05 The 305-type telephone set shown in Figs. 6 and 7 is equipped with a key in the base. The key is in series with the ringer circuit and is used for ringer cutoff. When this set is used, there must be another ringer permanently connected to the line.



Fig. 6 — 305C Telephone Set — Exterior

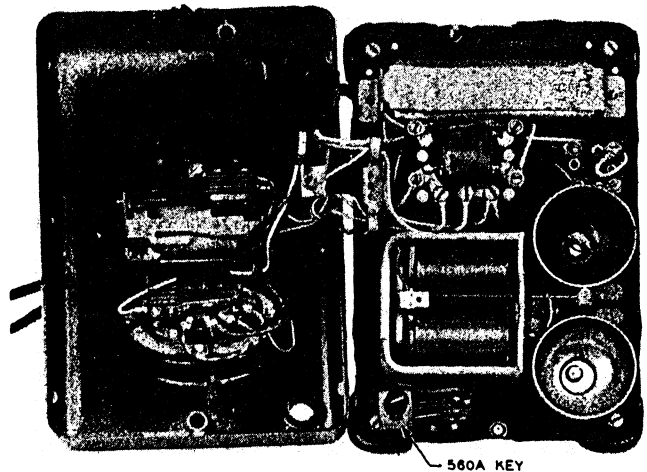

Fig. 7 — 305C Telephone Set — Interior

2.06 The 306-type telephone set is for use on common battery 4-party full selective and 8-party semiselective service. It is similar to the 302-type except that it employs an electron tube and a B3A ringer instead of a ringing capacitor and a B1AL ringer. (See Fig. 8.)

2.07 The 307-type telephone set is a local battery talking, common battery signaling set. Where a common source of transmitter battery supply is used for more than one set, the 307E, F, and G sets equipped with an F2B handset are used; a battery supply filter is used in the battery supply circuit. (See Fig. 9.)

2.08 The 309-type telephone set is for use in local battery talking, common battery signaling areas for 4-party full selective and 8-party semiselective service. It is similar to the 307-type except that it employs an electron tube and a B3A ringer instead of a ringing capacitor and a B1AL ringer.

2.09 The 332- and 334-type telephone sets, shown in Figs. 10 and 11, provide amplification for incoming speech by the addition of the 111B amplifier. The right-hand plunger serves as an on, off, and volume-control switch. The plunger can be rotated in either direction to select one of three volumes: low (L), medium (M), and high (H). The volume in use is determined by the designation facing the front of the set. These telephone sets require a 4-1/2-volt dc battery for operation of the amplifier. See the C Section entitled Dry Cell Batteries and Battery Boxes.

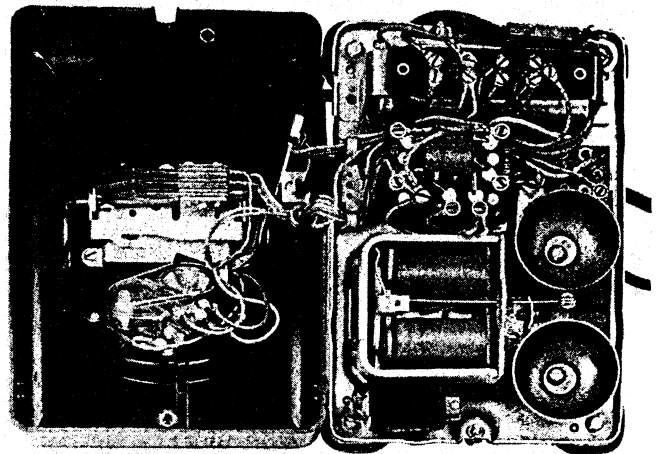

Fig. 9 — 307C Telephone Set — Interior

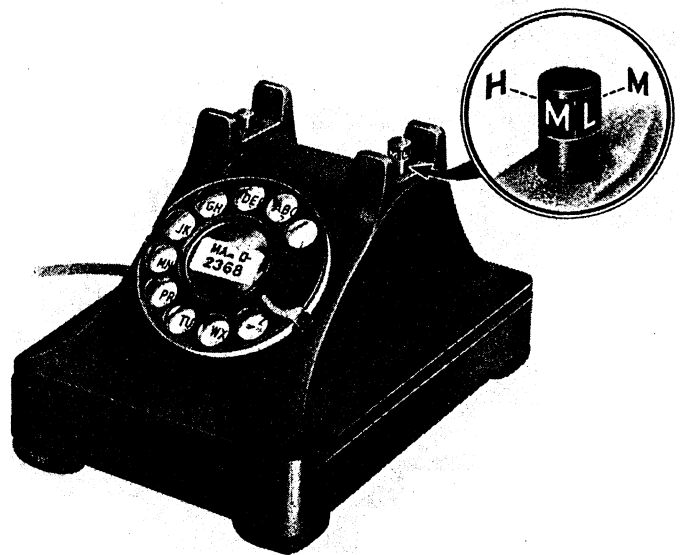

Fig. 10 — 332C or 334C Telephone Set — Exterior

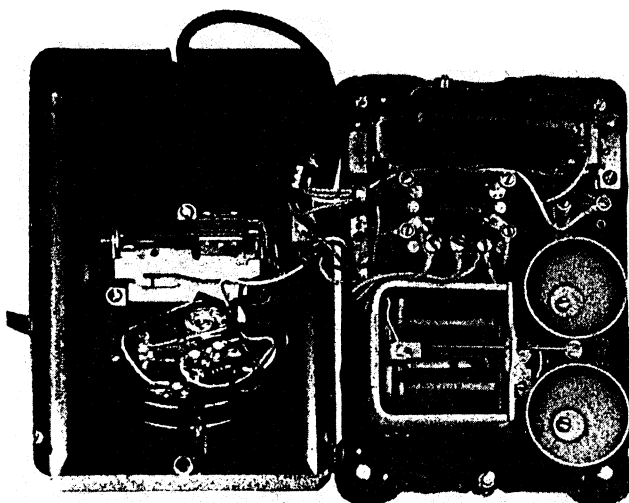

Fig. 8 — 306C Telephone Set — Interior

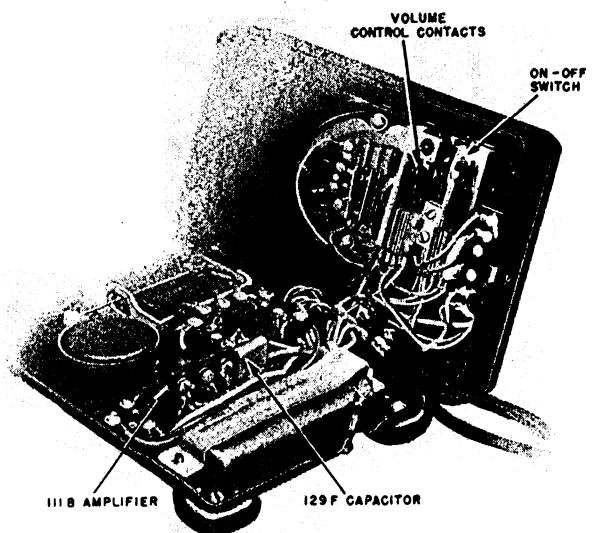

Fig. 11 — 332C or 334C Telephone Set — Interior

SECTION C38.545

2.10 The 354-, 356-, and 357-type telephone sets are identical in external appearance and are to be mounted on vertical surfaces.

- The 354-type telephone set is used on common battery nonpolarized ringing lines (see Figs. 12 and 13).
- The 356-type telephone set is used on common battery stations for 4-party selective and 8-party semiselective service (see Fig. 14).
- The 357-type telephone set is used at local battery talking, common battery signaling stations (see Fig. 15).
- Substitute an F2B handset for the F1A or F1G handset when the transmitter battery for more than one LBT-CBS telephone set is obtained from a common source of supply, such as a battery feeder from the central office. Under this condition, a filter is necessary in each transmitter circuit.

3.00 ASSEMBLY OF PARTS

3.01 On 302-type telephone sets, the base plate and housing are joined by a fabric strap which permits the telephone set to be opened to

an angle of at least 180 degrees. When closed, the housing is secured to the base plate by two captive mounting screws, which have either a captive lock-washer or internal tooth lockwasher under the head of the screw.

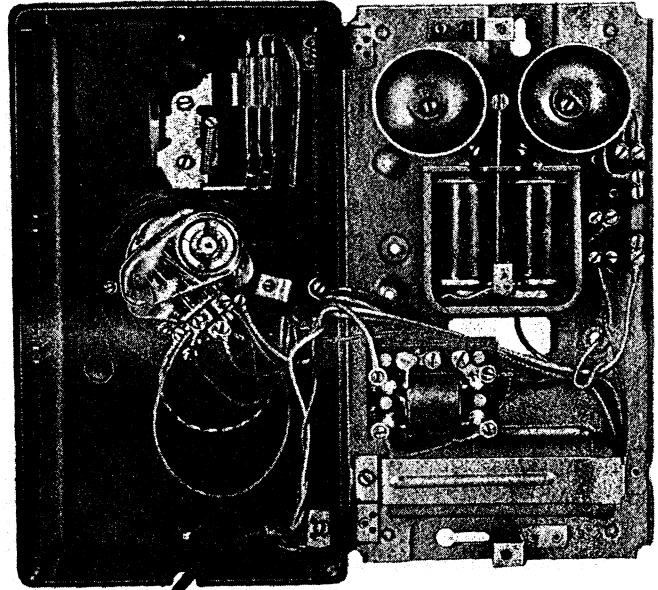

Fig. 13 — 354C Telephone Set — Interior

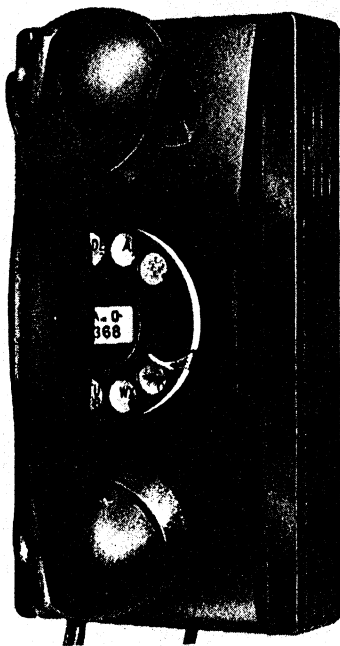

Fig. 12 — 354C, 356C, or 357C Telephone Set — Exterior

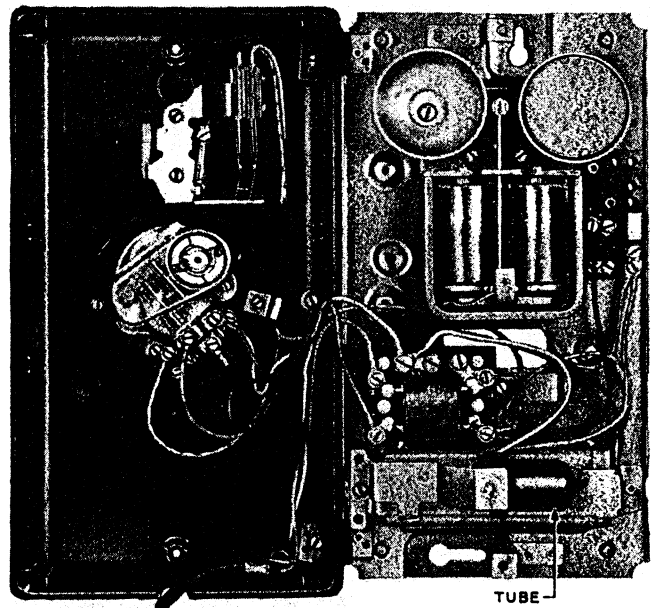

Fig. 14 — 356C Telephone Set — Interior

3.02 The 354-type wall telephone sets are joined by two fabric straps which permit the telephone set to be opened to an angle of at least 180 degrees (see Fig. 14). When closed, the housing is secured to the base plate by two captive mounting screws.

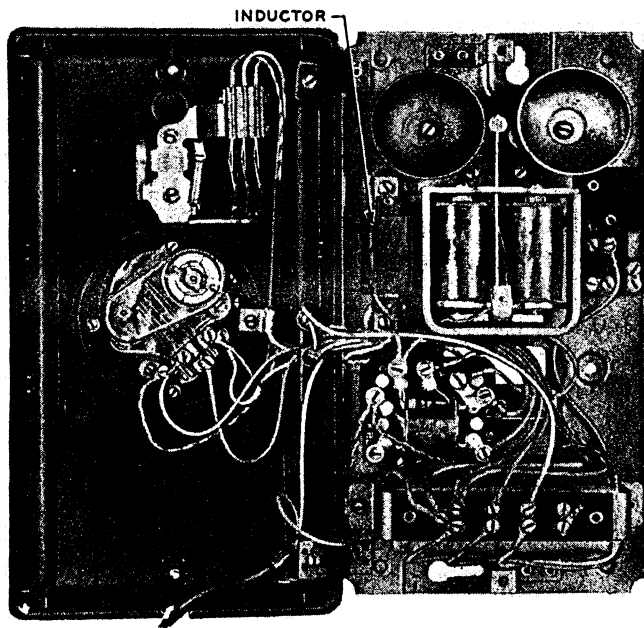

Fig. 15 — 357C Telephone Set — Interior

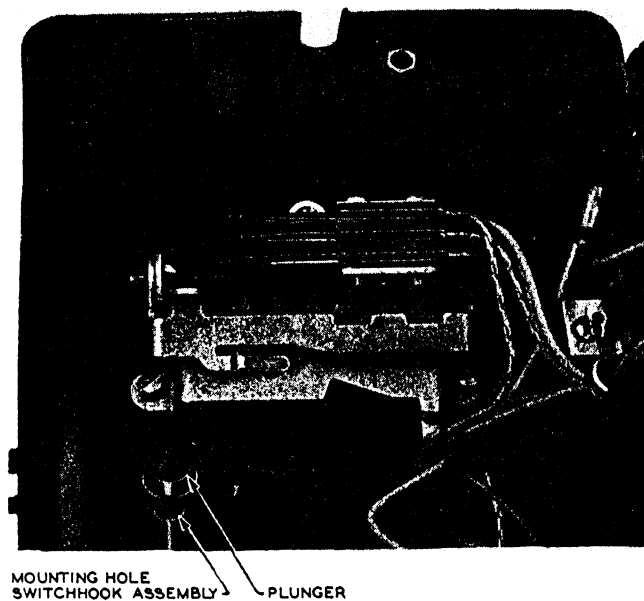

Fig. 16 — Plunger and Switchhook Assembly

3.03 The plungers and handhole cover on the 302-type telephone sets are held in place by the switchhook assembly. Fig. 16 shows the mounting of the switchhook assembly.

3.04 Fig. 17 shows the mounting of the switchhook assembly in the 354-type telephone set.

3.05 Fig. 18 shows the assembly of a 6A dial with a 59A adapter in the 302G telephone set. Fig. 19 shows the assembly of a 5H dial in the 354C telephone set.

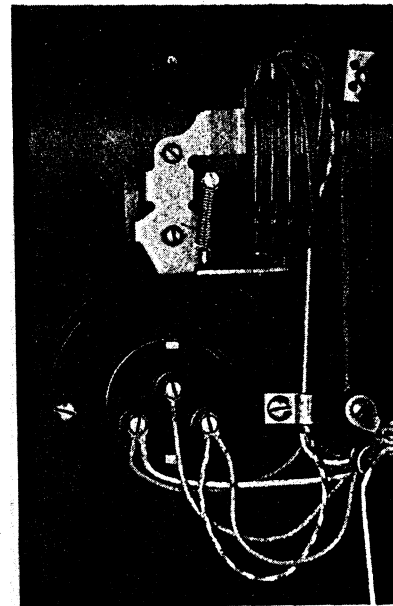

Fig. 17 — Switchhook and 94A Apparatus Blank Assembly

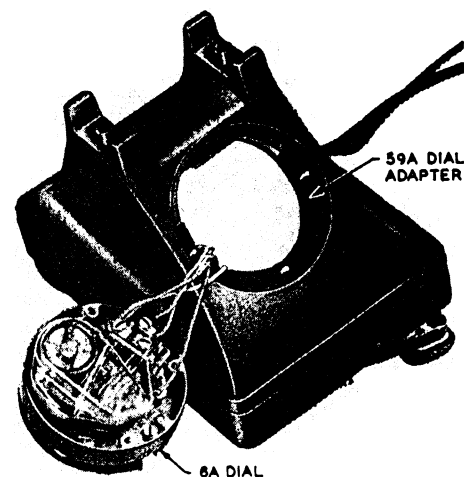

Fig. 18 — Dial Assembly — 302G Telephone Set

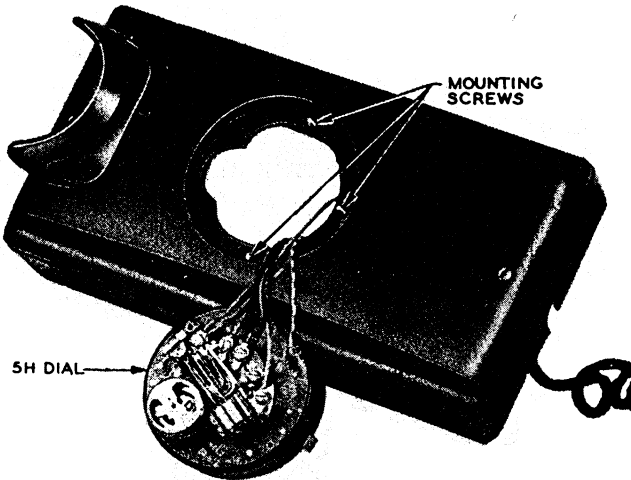

Fig. 19 - Dial Assembly - 354C Telephone Set

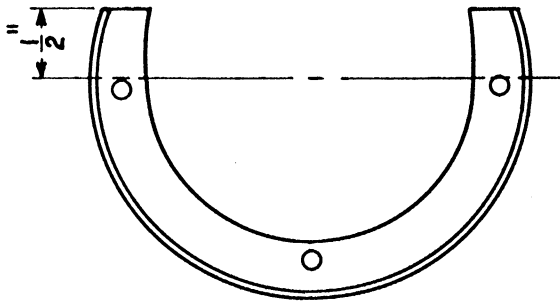

Fig. 20 - Modified 59A Dial Adapter

3.06 When a 6-type dial is used as a replacement and where a 59A dial adapter is present, it may be necessary to alter the dial adapter to provide clearance without binding between the plastic cover on the 6-type dial and the dial adapter. This may be accomplished by cutting the adapter to the approximate dimensions shown in Fig. 20. If this is done, the adapter may be used interchangeably with 5- or 6-type dials.

3.07 Position the cord tips and dress the wires connected to the terminals of the dial so that they do not short adjacent terminals or interfere with moving parts.

3.08 On desk-type sets the terminals of the 6-type dial may obstruct the ringer clapper rod when the ringer is mounted on a triangular mounting bracket. To provide the necessary clearance, two captive mounting washers should be placed on each of the mounting screws which hold the upper housing to the base plate of the telephone set (see Fig. 22).

3.09 The 82A apparatus blank is superseded by the 94A apparatus blank for use in the 300 series telephone sets. Figs. 21 and 17, respectively, show the assembly of each apparatus blank.

3.10 Ringer assembly where the P-43A293 bracket is part of the telephone set mounting is shown in Fig. 22. When the P-298695 bracket is part of the telephone set mounting, mount the ringer as shown in Fig. 23. The left ringer gong is omitted for clarity.

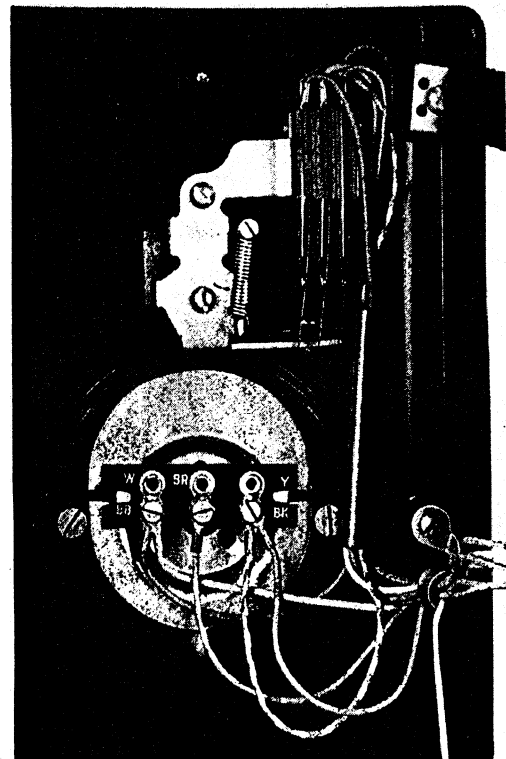

Fig. 21 - Assembly - 82A Apparatus Blank

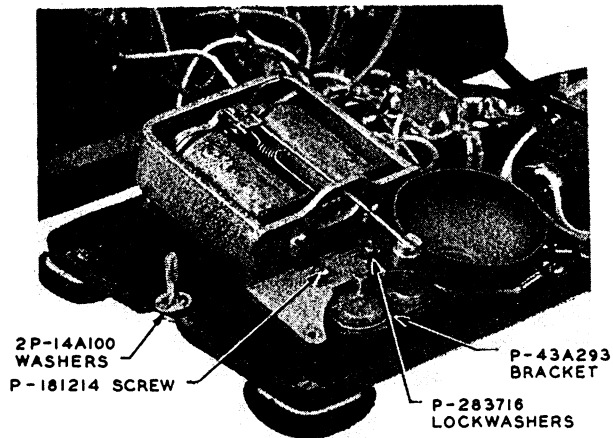

Fig. 22 — Ringer Assembly Using P-43A293 Bracket

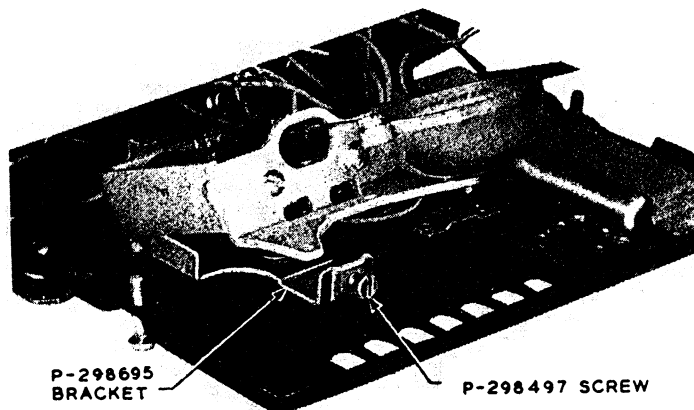

Fig. 23 — Ringer Assembly Using P-298695 Bracket

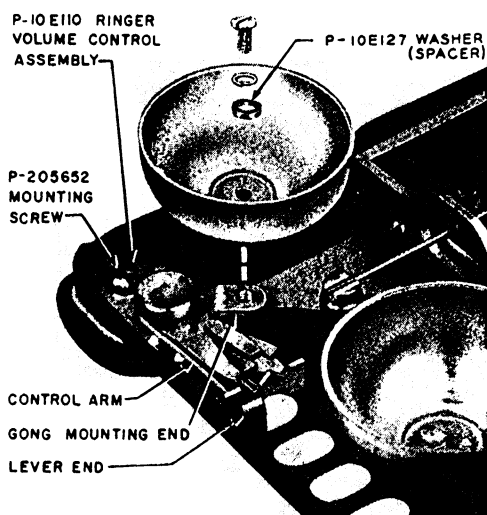

Fig. 24 — Ringer Volume — Control Assembly

3.11 The ringer volume control assembly may be provided on all 300 series desk-type telephone sets (see Fig. 24).

- Washer P-10E127 is not required on 306C telephone sets.
- Assembly must be removed in order to replace ringer.
- Ringer volume is varied by the control arm lever which protrudes through the ringer port in the base of set. The left ringer gong is mounted on gong end of control arm, and may be moved to three positions (low, medium, and high) by operation of volume-control lever (see Fig. 25).
- To remove assembly, remove mounting screw which also mounts the right front foot to the base, move assembly toward front of base, and lift up to disengage mounting bracket ears and hook which aid in holding assembly in place.
- When placing assembly, mounting bracket hook and ears must be in place before mounting screw is secured.

3.12 Cords shall be properly anchored within the mounting. The mounting cord should be attached first, towards the hinge of the set, and then the handset cord should be attached. Cord leads should be dressed to avoid interference with ringer gongs. Two new vinyl-jacketed mounting

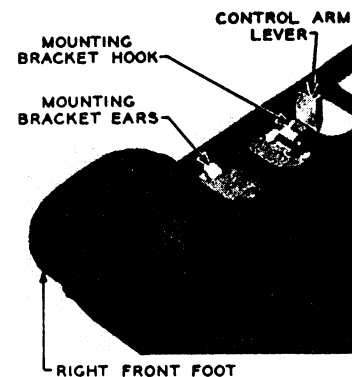

Fig. 25 — Mounting Bracket

SECTION C38.545

ords having a combination stay cord hook and S hook assembly are available for replacement of neoprene and vinyl-jacketed cords.

3.13 The induction coil in the 300 series telephone set for indoor locations is mounted as shown in Fig. 26.

3.14 The 195-type capacitor in the 300 series telephone set for indoor locations is mounted as shown in Fig. 27.

4.00 COLORED SETS — ASSEMBLY OF PARTS

The assembly of parts for colored telephone sets in the 300 series is generally the same as for black telephone sets. If replacement of these sets is necessary, use 500 series colored telephone sets.

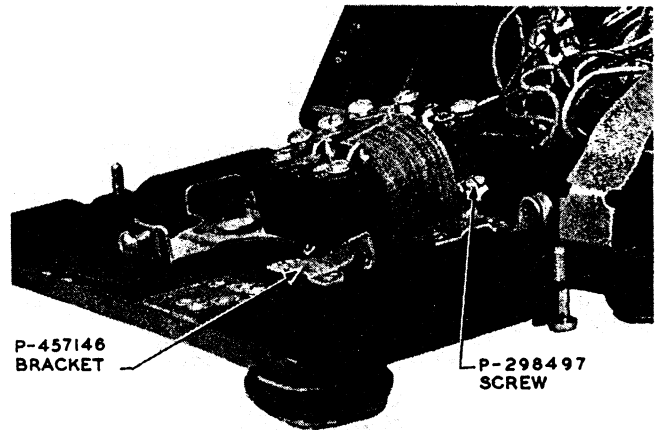

Fig. 26 — Induction Coil Assembly

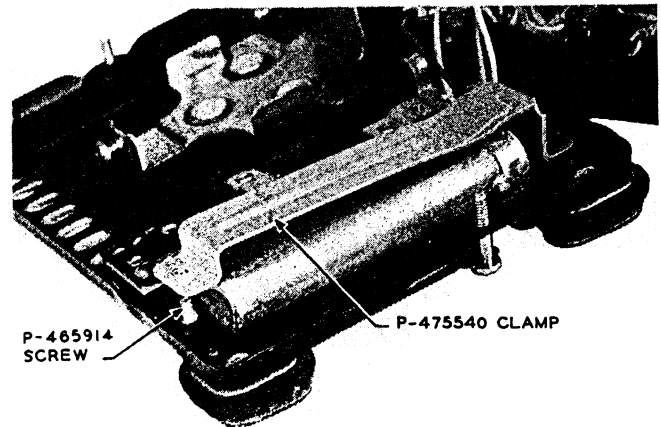

Fig. 27 — Capacitor Assembly